

DOMIS NEW

Art.-Nr.

406 086
406 087
406 088
406 089

	800	1/10
	433	
	1850	
		mm
		v0
		15-2025

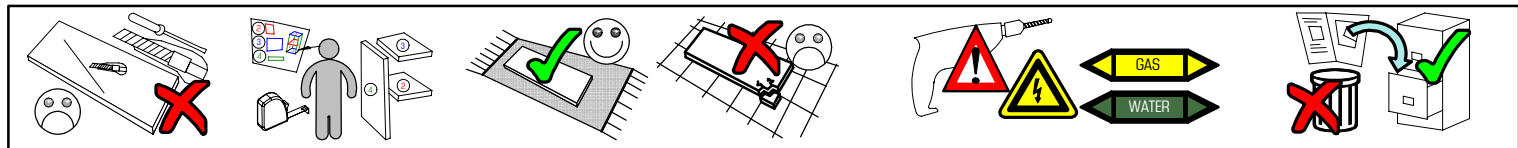
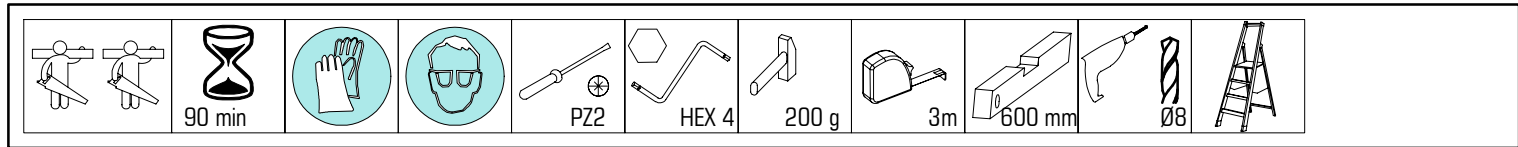

ID	ID			
22085	②	830*410*16	1x	1/2
22086	③	766*410*16	1x	1/2
22059	④	766*96*16	2x	2/2
22087	⑤	830*410*16	1x	1/2
22088	⑥	800*430*22	1x	1/2
22089	⑦	766*400*16	1x	1/2
22063	⑧	742*396*3	2x	1/2
22090	⑨	574*396*16	1x	2/2
22091	⑩	574*396*16	1x	2/2
22092	⑪	794*150*16	1x	1/2
19738	⑫	350*100*16	1x	1/2
22105	⑬	708*100*16	1x	1/2
19740	⑭	350*100*16	1x	1/2
22093	⑮	738*356*3	1x	1/2
22068	⑯	999*302*16	1x	2/2
22069	⑰	999*302*16	1x	2/2
22070	⑱	766*302*16	2x	2/2
22071	⑲	766*292*16	1x	2/2
22072	⑳	396*396*16	1x	1/2
22073	㉑	396*396*16	1x	1/2
22074	㉒	390*794*3	1x	1/2
22075	㉓	794*615*3	1x	2/2
22094	㉔	766*100*16	1x	2/2

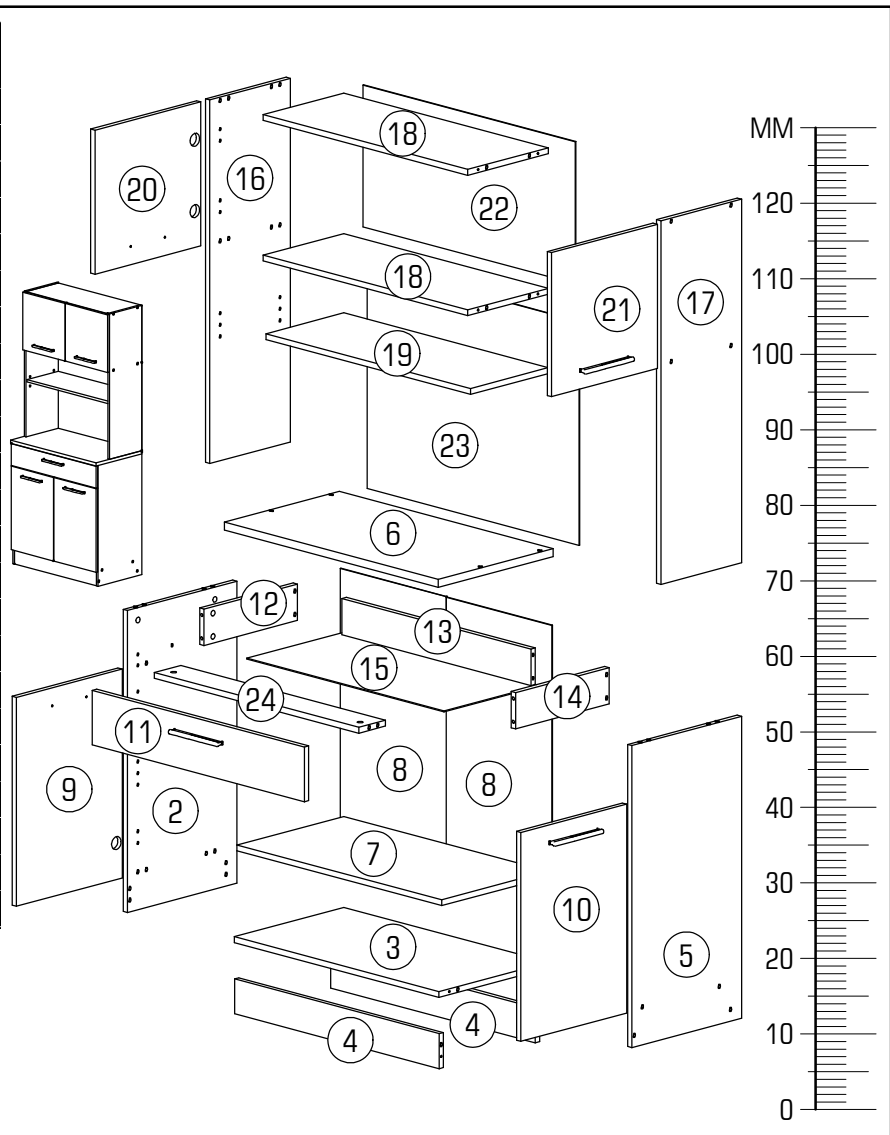

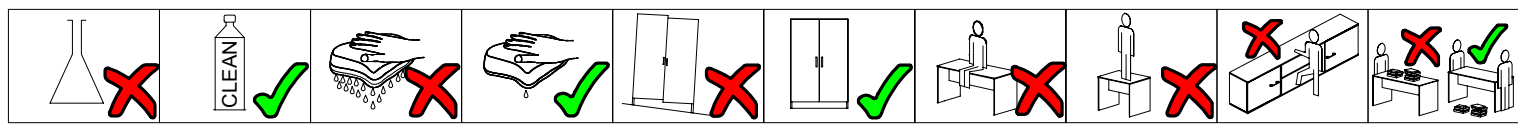

	27000,00		22300,00		70013,01		70021,01		300091,00		31103,00		
A	4x	B	22x	C	20x	D	10x	E	10x	F	6x	G	16x
	22244,01		22255,00		24101,00		21102,00		22236,00		22243,00		22280,00
H	8x	I	1x	J	1x	K	50x	L	14x	M	24x	N	10x
	24008,00		35101,01		32029,00		33009,02		33009,02		36002,07		36002,07
O	14x	P	8x	Q	5x	W1	1x	W2	1x	Y1	8x	Y2	8x
	22305,02		22305,02		22305,02		22305,02		22305,02		22305,02		22305,02
V	4x	W	4x	X	4x	Y	4x	Z	4x	AA	4x	AB	4x

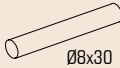
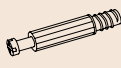
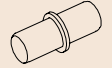
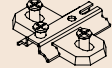

2/10 DOMIS NEW

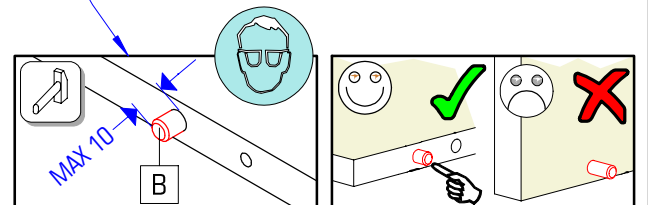
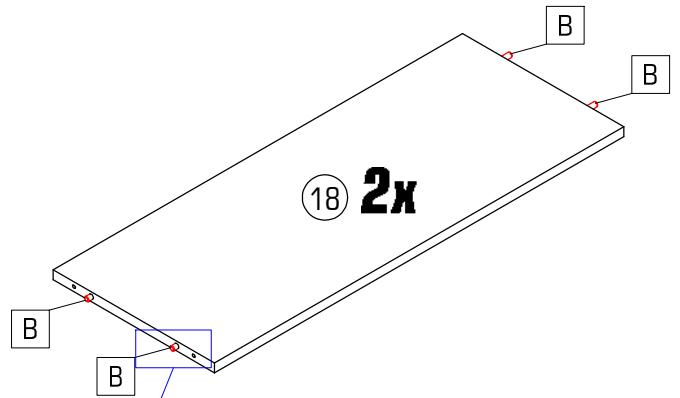
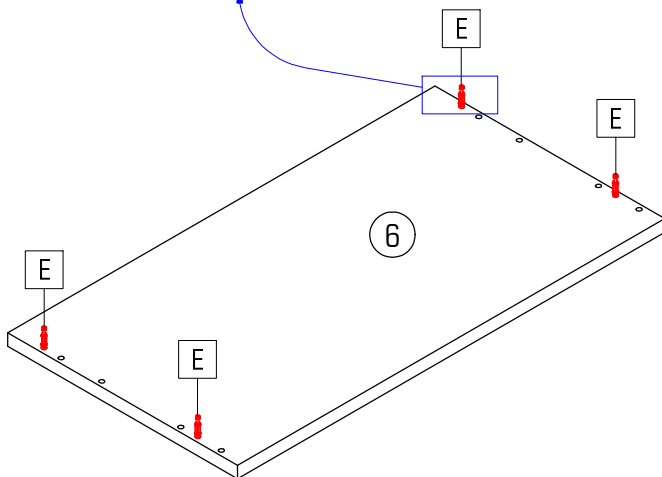
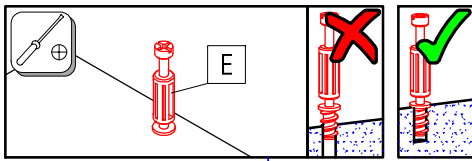
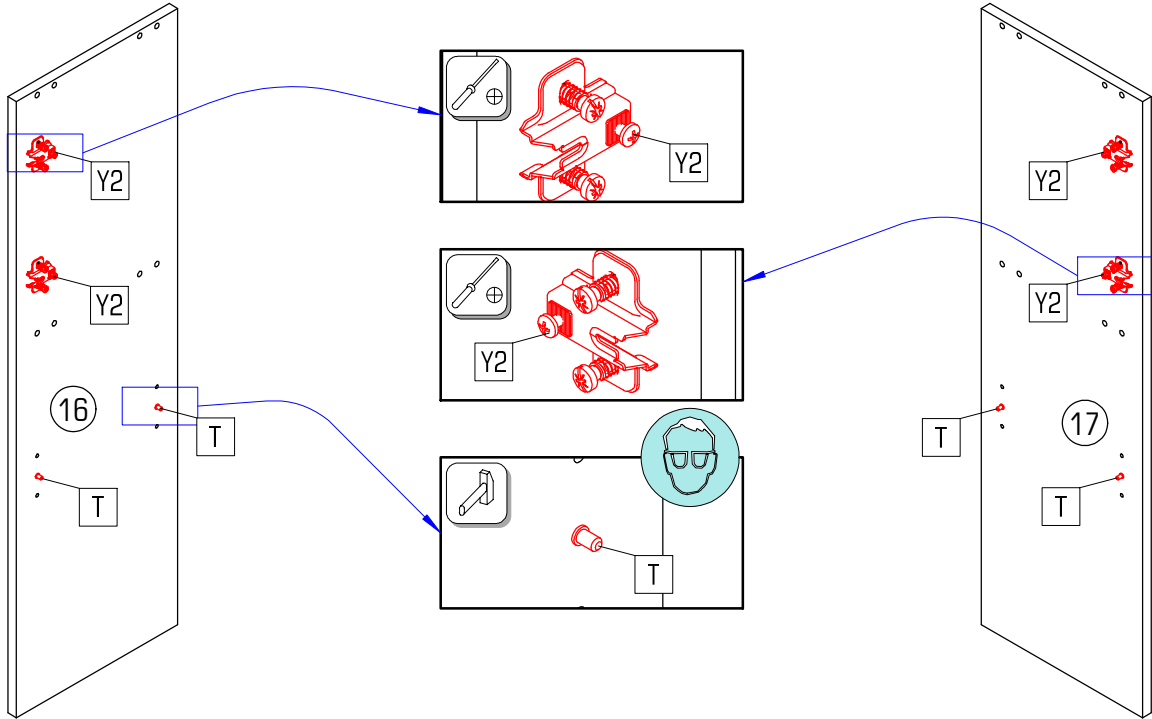
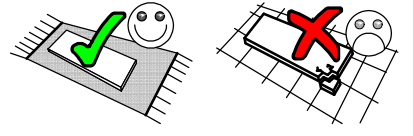
			
B	8x	E	4x
		T	4x
		Y2	4x

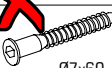

	Ø7x50
C	8x

	Ø7x60
Z	4x

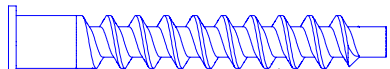
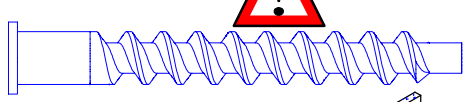
 M 1:1

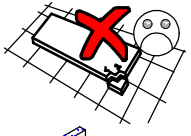
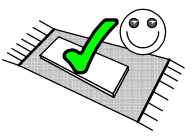

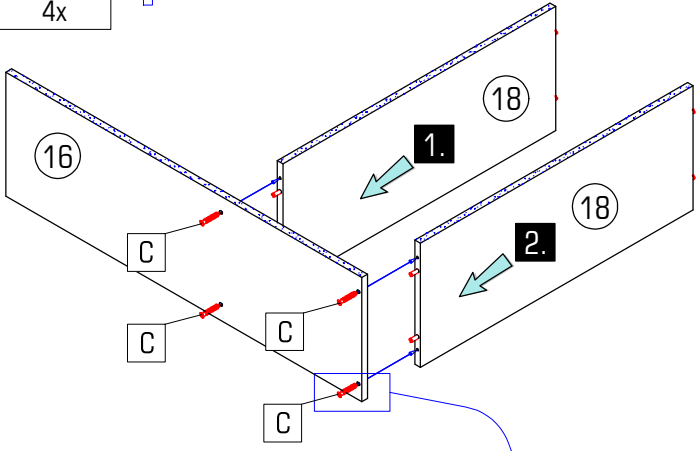

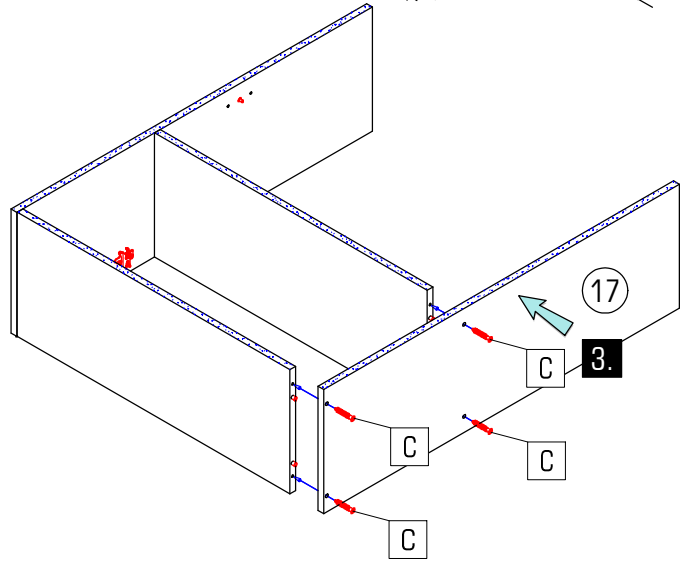

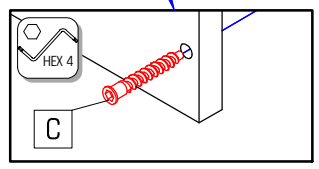
	Ø1,6x20		Ø7x60
M	14x	Z	4x

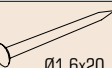
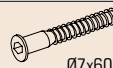
A=B

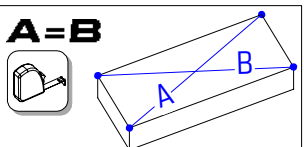

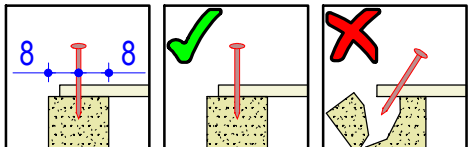

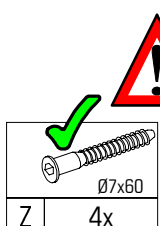
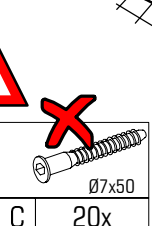

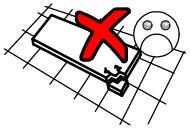
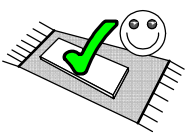

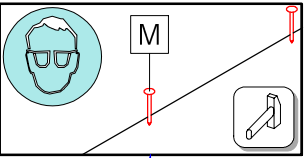

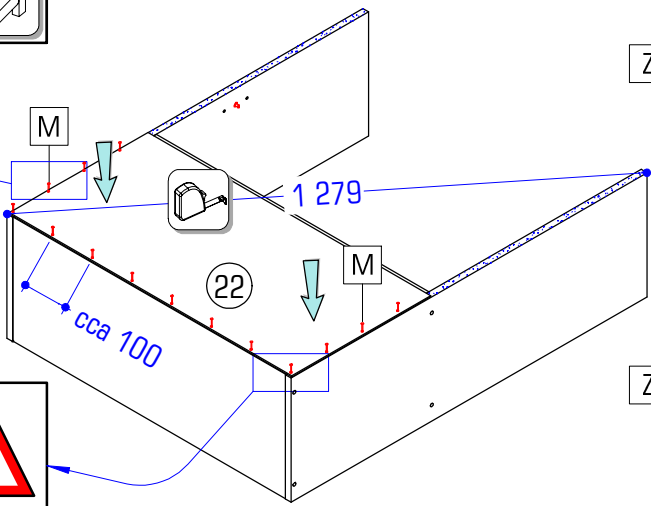

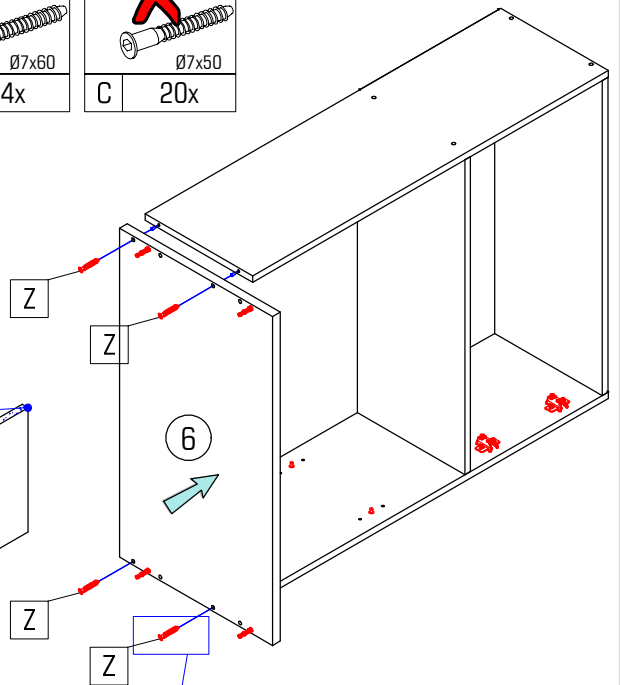

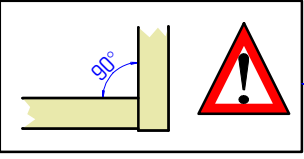

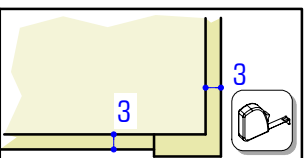

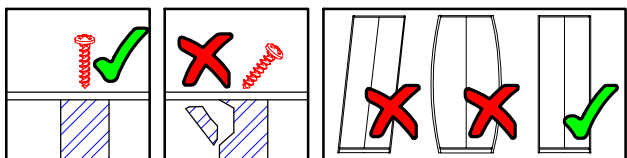

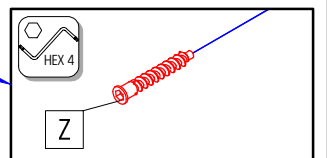



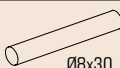

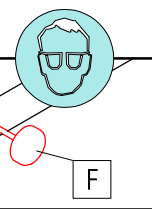
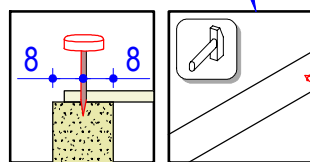
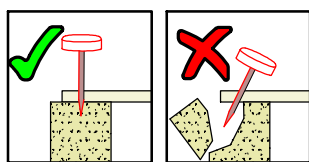
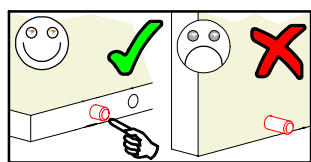
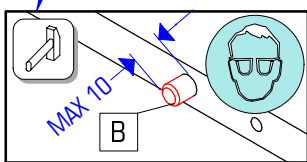
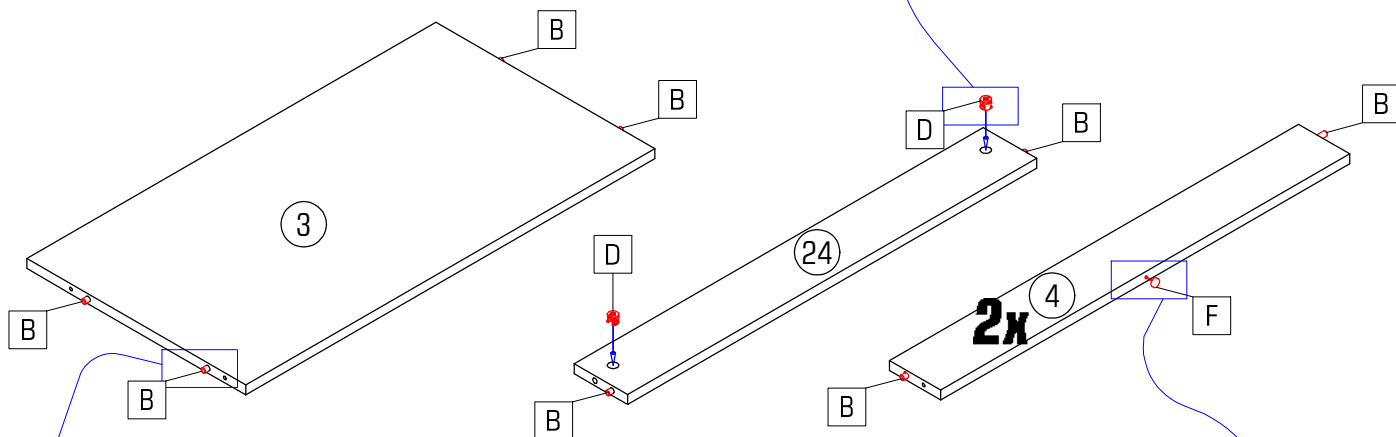
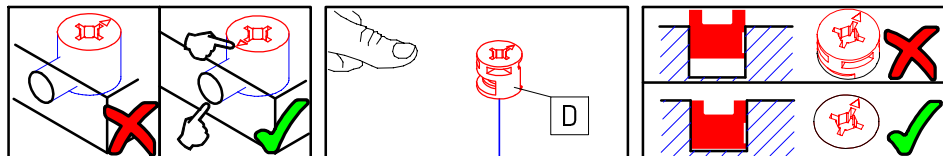

4/10 DOMIS NEW

		
B 10x	D 2x	F 2x

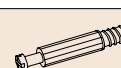

			
D 4x	E 4x	Q 2x	V 1x

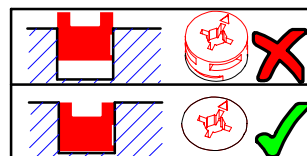
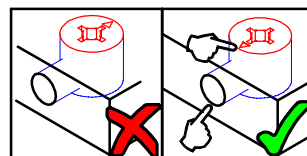
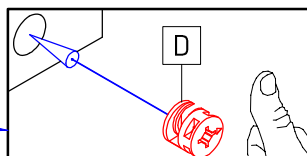
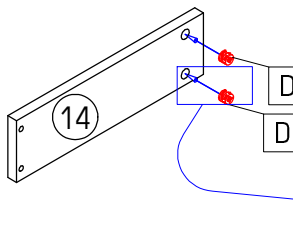
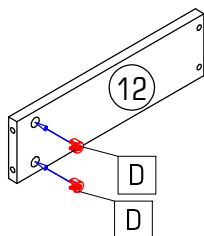
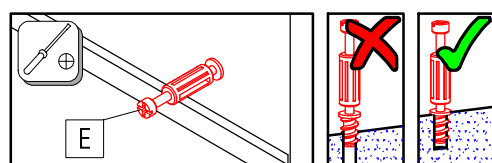
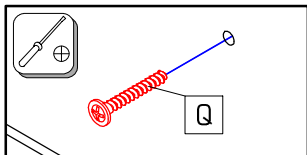
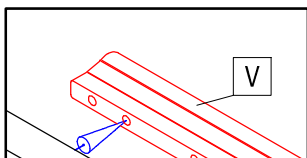
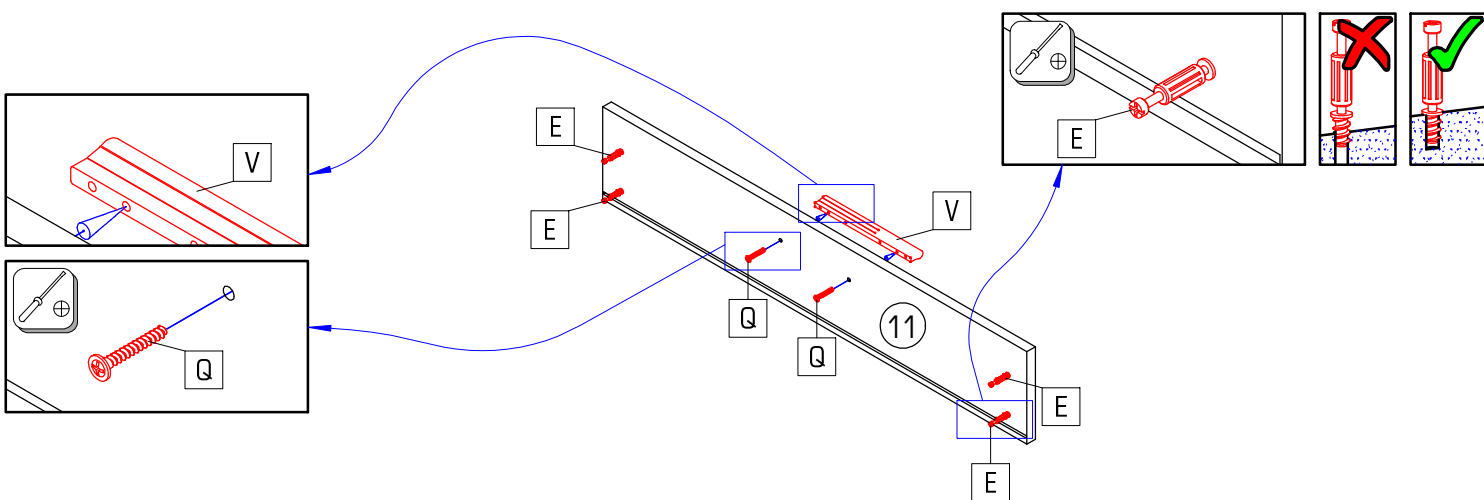

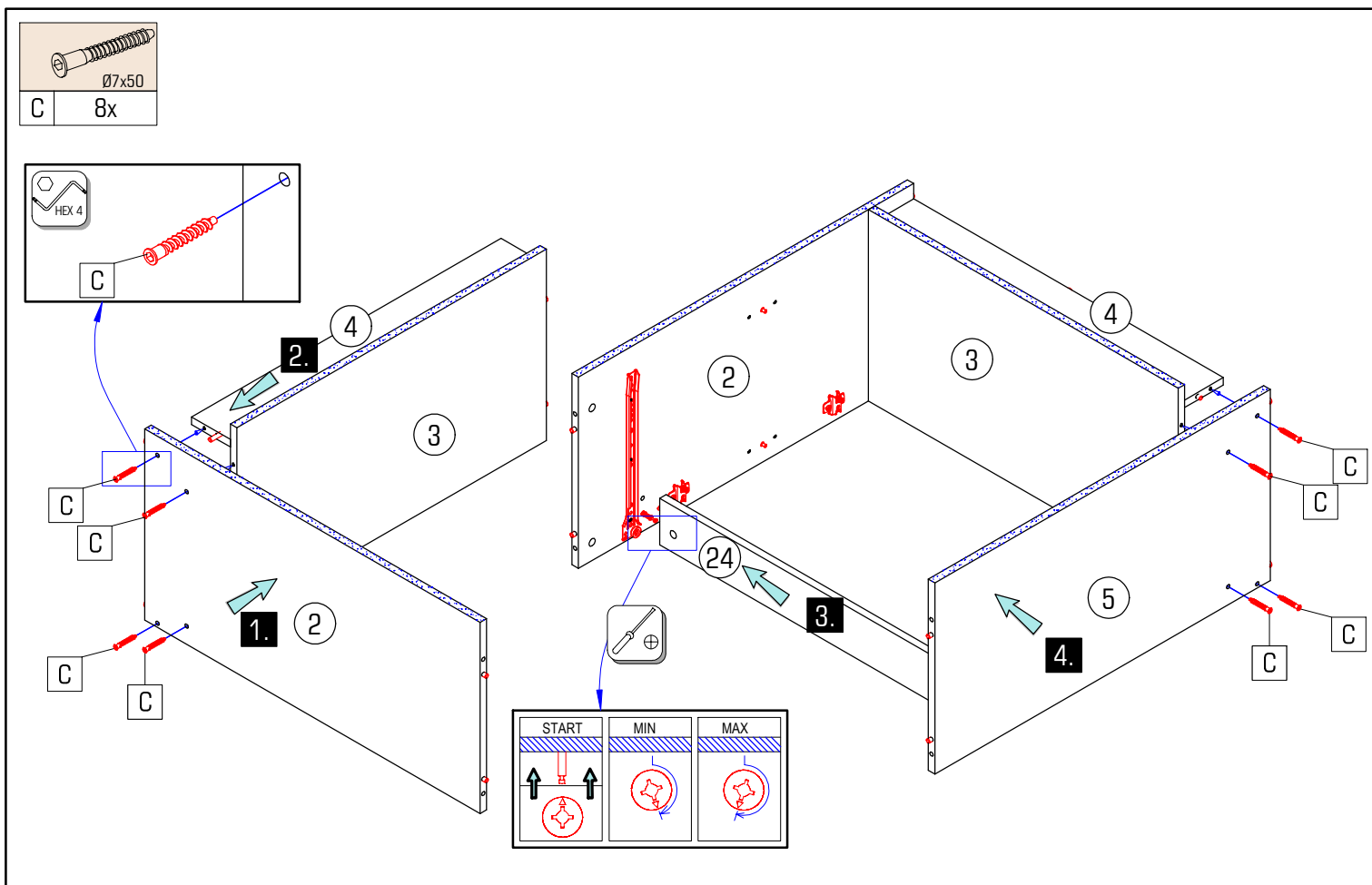
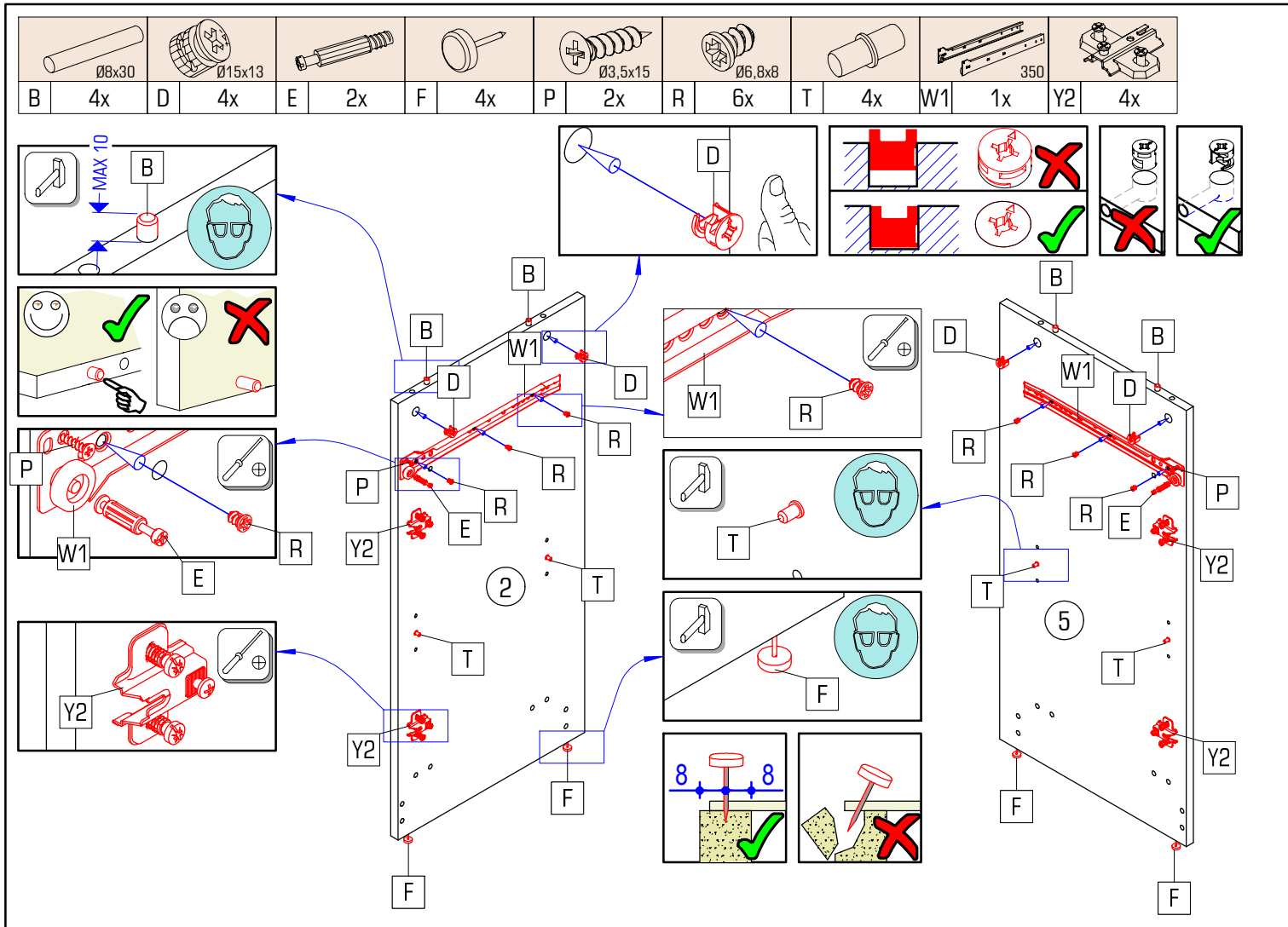

6/10 DOMIS NEW

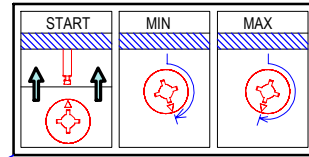
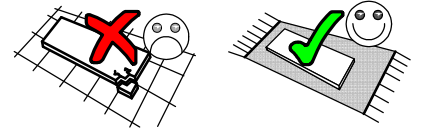
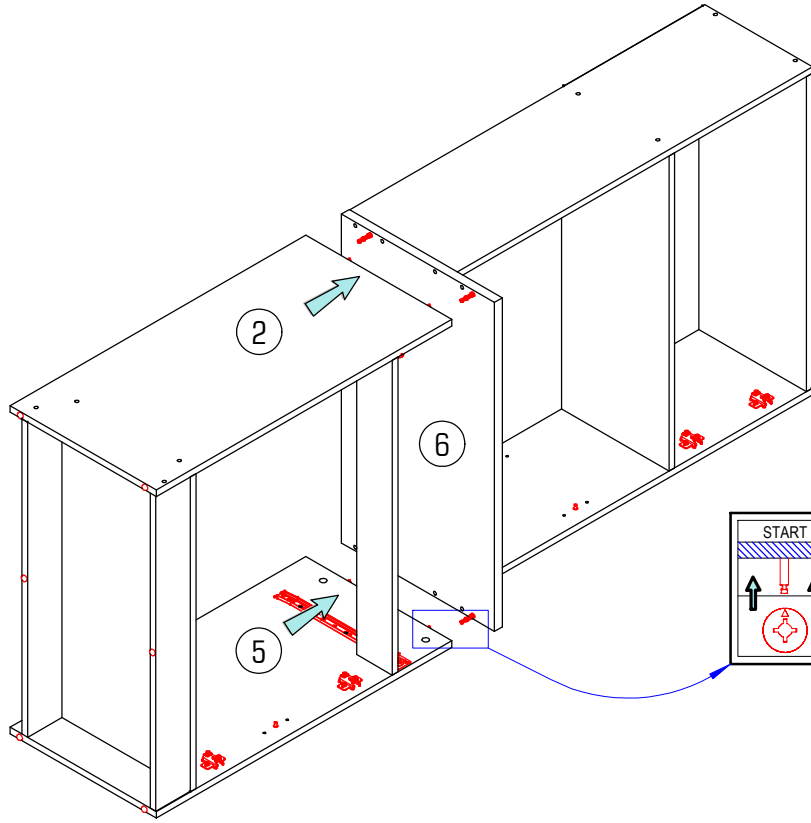

G 16x	M 34x	N 14x	S 14x
	Ø1,6x20	Ø2,5x16	3,0

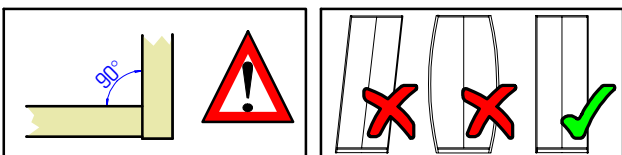
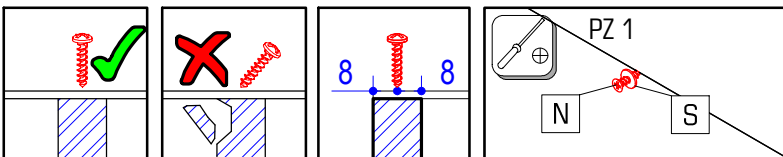
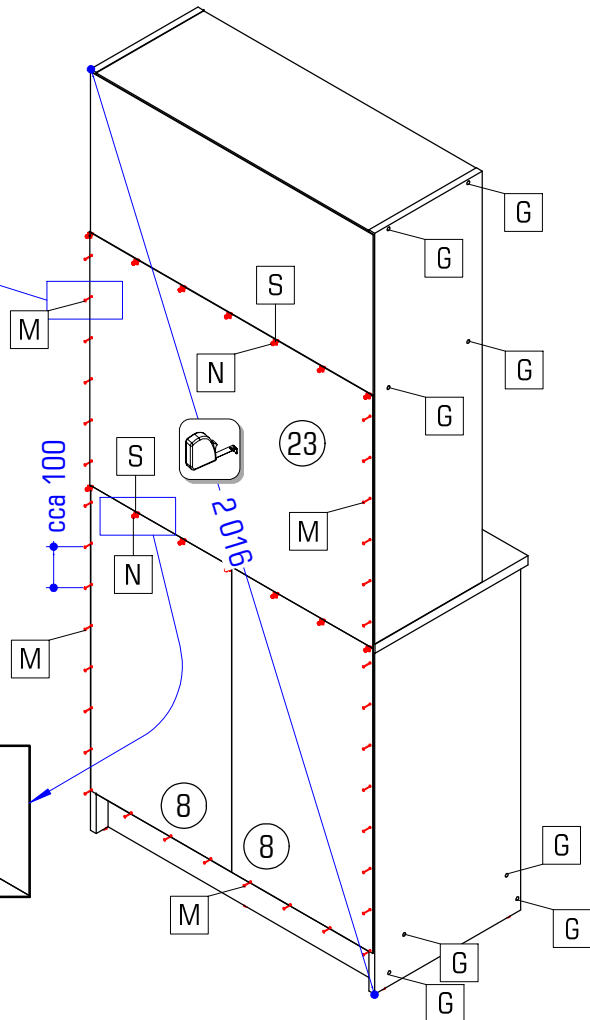
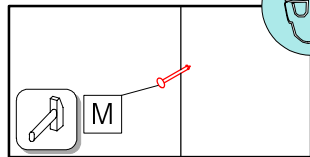
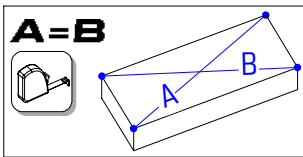
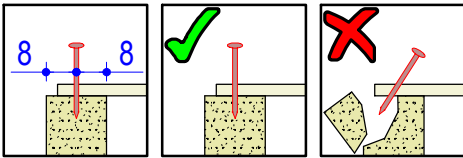

H 1x	J 2x	K 1x	L 1x

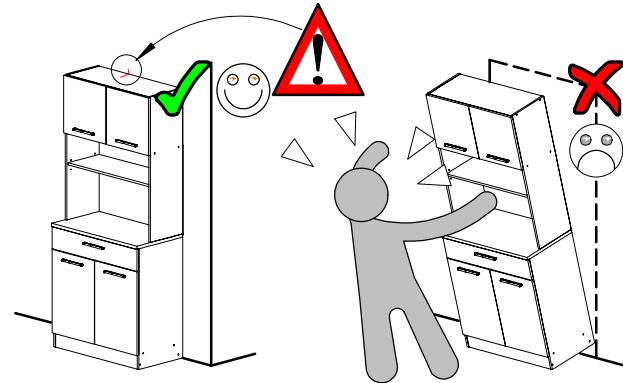
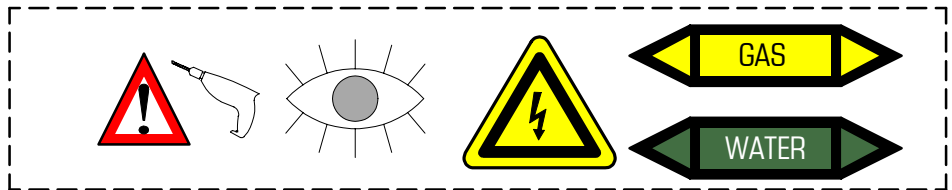
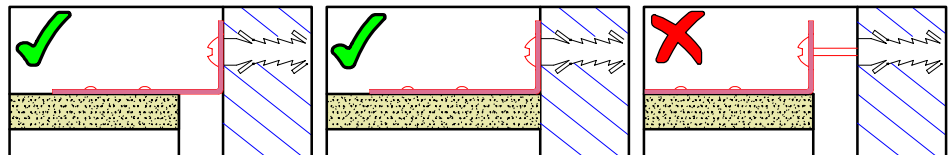
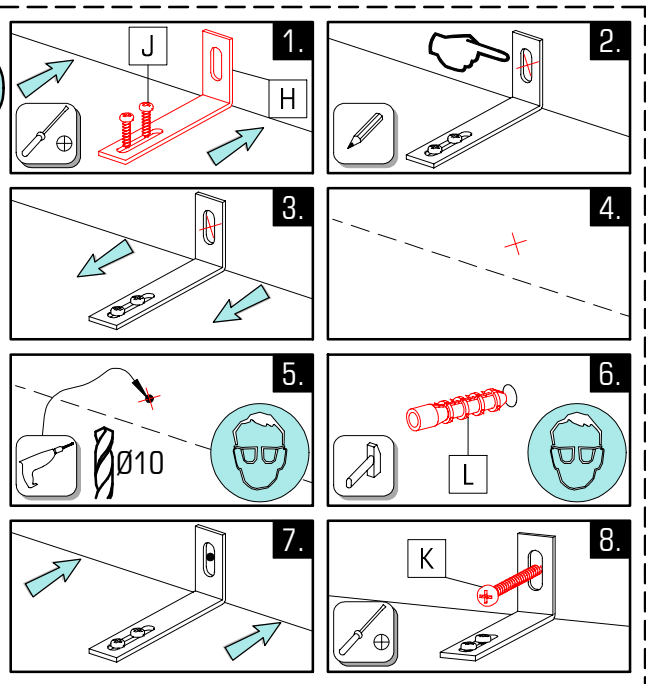
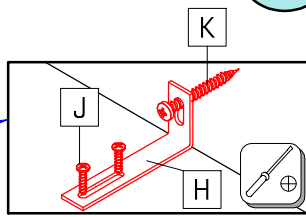
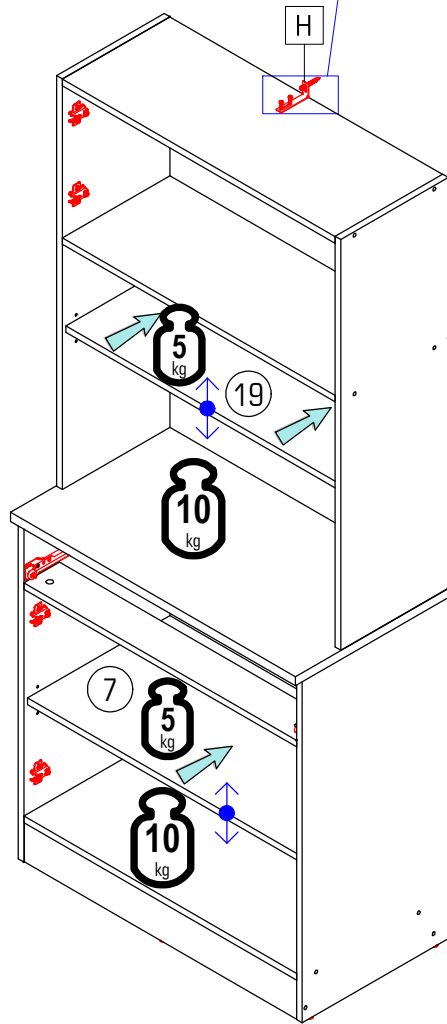
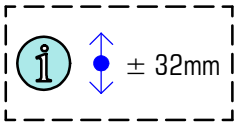

SK	VÝSTRAHA
CZ	VAROVÁNÍ
HR	UPOZORENIE
DE	WARNUNG
HU	FIGYELEM
PL	OSTRZEŻENIE
RO	AVERTIZARE
EN	WARNING
SI	OPOZORILLO

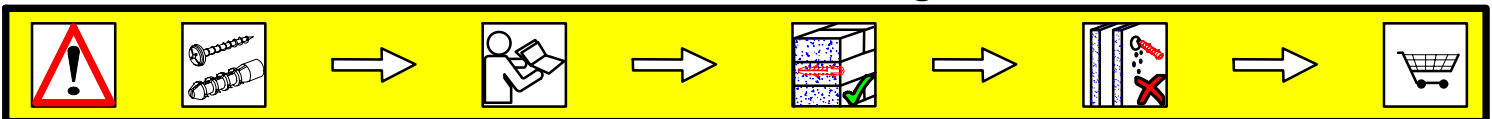

PL Uwaga! Ścianę należy sprawdzić przed montażem. Dołączone uniwersalne kolki rozporowe są odpowiednie tylko do stosowania w mocnych murach, takich jak beton lub cegła. Nie rób z pomocą kółków oporowych murowanych, takich jak pustak, lekka kostka, powierzchnie takie jak płyty gipsowo-kartonowe lub inne systemy ram. Jeśli dotyczy, muszą to być określone kolki rozporowe być użyty! Są one dostępne w specjalistycznym sklepie niezgodność producent / sprzedawca lub importer nie ponoszą odpowiedzialności.

RO Prudență! Zidul trebuie examinat înainte de asamblare prizele de perete sunt adecvatenumai pentru utilizarea în zidurile fermă, cum ar fi betonul bloc sau cărămidă. Nu folosiți zidăria zidurilor de perete, cum ar fi cărămida goală, blocul ușor, suprafețe cum ar fi gips-carton sau altă încadrare sisteme. Dacă este cazul, trebuie folosite anumite prize de perete! Acestea sunt disponibile la un magazin specializat (magazin de hardware) . În caz de nerespectare, producătorul / vânzătorul cu amănuntul sau importatorul nu își asumă răspunderea.

SI Pozor! Pred montažo preverite stanje stene. Priloženi univerzalni mozniki so izključno samo za uporabo na čvrstem zidovju, kot sta beton in opeka. Stenski mozniki se ne smejo uporabljati pri zidovju kot so votlina opeke, zidaki za lahko gradnjo, mavčne plošče ali druge okvirne gradnje. Pri teh zidovjih morate v danih primerih uporabljati posebne moznike. Ti so na voljo v specializiranih trgovinah (trgovinah z gradbenim materialom) Pri upoštevanju se s strani proizvajalca/trgovca in uvoznika ne prevzame jamstvo.

DE Achtung! Die Wandbeschaffenheit ist vor der Montage unbedingt zu prüfen. Die beigelegten Universaldübel sind ausschließlich nur zur Verwendung für festes Mauerwerk wie Beton/Ziegel. Die Mauerdübel dürfen nicht bei Mauerwerk wie Hohlraumziegel, Leichtbausteinen, Gipskartonplatte oder anderer Rahmenbauweise verwendet werden. Bei diesen Mauerwerken sind gegebenenfalls Spezialdübel zu verwenden! Diese sind in einem Fachgeschäft erhältlich. Bei Nichterhaltung wird seitens Produzenten/Händler und Importeur keine Haftung übernommen.

HR Pažnja! Prije montaže obvezno provjerite svojstvo zida. Priložene univerzalne tiplje namijenjene su isključivo za masivne zidove od betona/opeke. Tiplje za masivne zidove ne smiju se koristiti za zidove kao npr šupljina opeka laki sastavni elementi, gips-kartonske ploče ili drugi modularni načini gradnje. Za te zidove potrebne su eventualno specijalne tiplje! Iste su dostupne u specializiranim trgovinama građevinskim materijalom. U slučaju nepridržavanja prethodno navedenih napomena, proizvođač/trgovac i uvoznik ne preuzimaju odgovornost!

HU Vigyázat! Szerelés előtt a falfelületet feltétlenül vizsgálja meg. A mellékelt univerzális tiplj kizárólag stabil falazathoz használható mint például beton/tégla. A fali tiplje nem használható könnyű építőkövekhez, üreg tégla, gipszkarton lapokhoz vagy más favázás építményekhez. Ezekhez a falfelületekhez csak speciális tiplik használhatóak, melyek szaküzletekben (barkácsruházakban) beszerezhetőek. Fentiek figyelmen kívül hagyása esetén a gyártó/kereskedő vagy forgalmazó nem vállal felelősséget.

EN Caution! The wall must be examined before assembly. The included universal wall plugs are only suitable for using in firm masonry such as concrete block or brick. Do not use the wall plugs masonry such as hollow brick, lightweight block, surfaces such as gypsum plasterboard or other framing systems. If applicable, particular wall plugs must be used! These are available at a specialised store (hardware store). In case of non-compliance, the manufacturer/retailer or importer do not assume liability.





CZ Upozornění! Před montáží je nutné zkontrolovat stav stěny. Přiložené univerzální hmoždinky jsou určeny pouze k použití pro pevné zdivo jako beton/cihly. Hmoždinky do zdi se nesmí používat u dutinová cihla, zdiva jako porývitý stavební kámen, sádrokartónová deska nebo jiný měkký materiál. U těchto zdiv jsou nutné použít speciální hmoždinky! Jsou k dostání v speciálních prodejnách se stavebním materiálem. Při nedodržení těchto pokynů výrobce/prodejce a dovozce neručí za způsobené škody.

SK Upozornenie! Pevnosť steny sa musí pred montážou bezpodmienečne skontrolovať. Priložené univerzálne hmoždenky používajte jedine pre pevné murivo ako je betón/tehla. Hmoždenky sa nesmú používať v prípade ľahkého stavebného muriva, dutá tehla, Sádorkartónová doska, alebo iných konštrukcií rámu. U týchto stien je nutné použiť špeciálne hmoždenky! Tieto je možné dostať v špecializovaných predajniach so stavebným materiálom. Pri nedodržaní pokynov nepreberajú výrobcovia/predajci a dodávateľia zodpovednosť za vzniknuté škody.

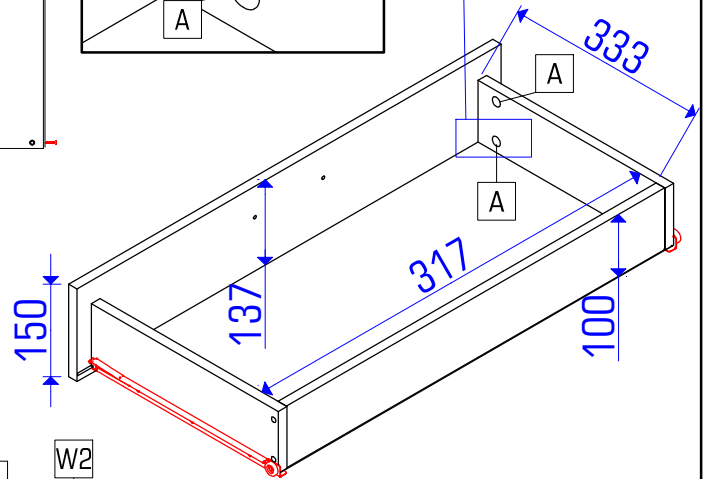
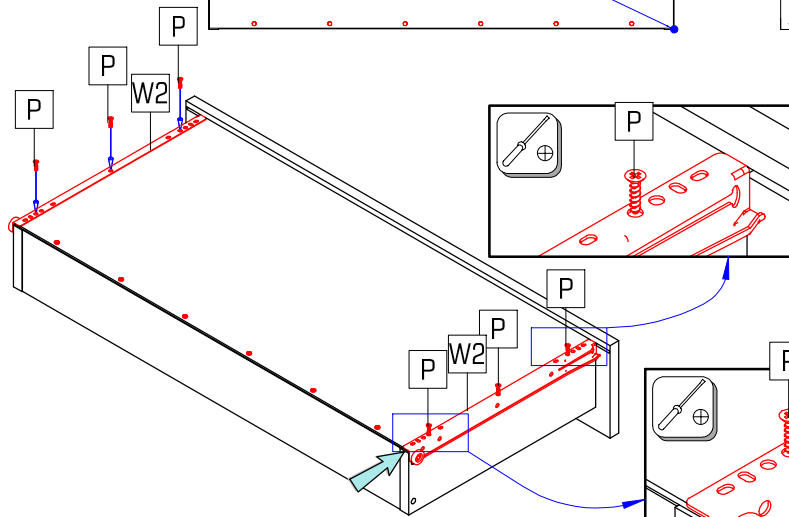
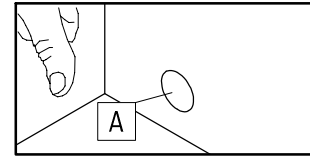
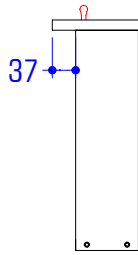
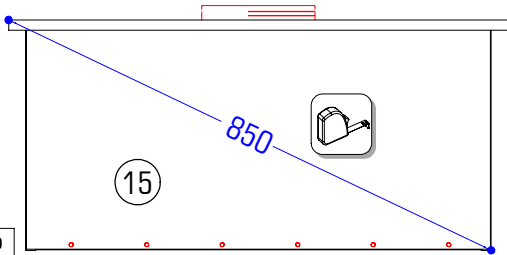
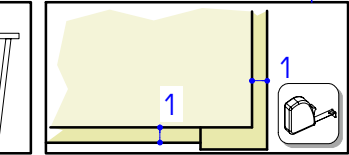
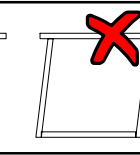
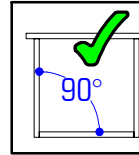
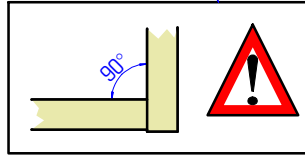
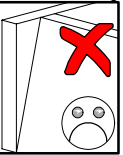
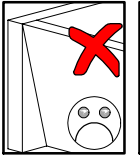
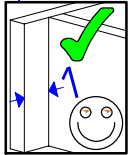
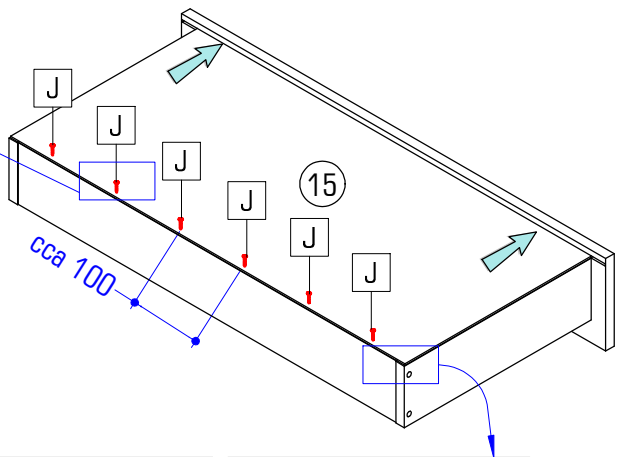
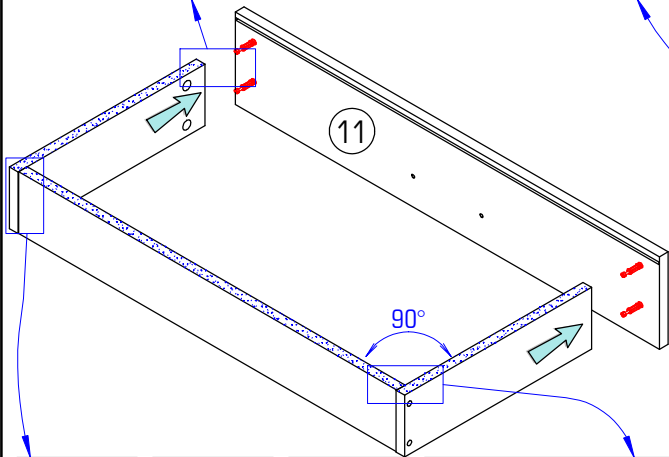
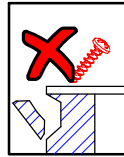
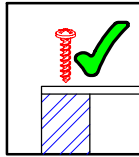
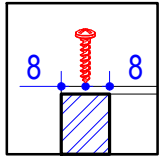
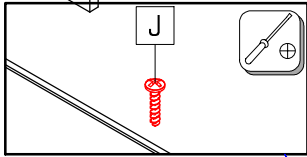
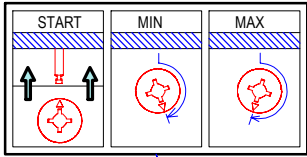
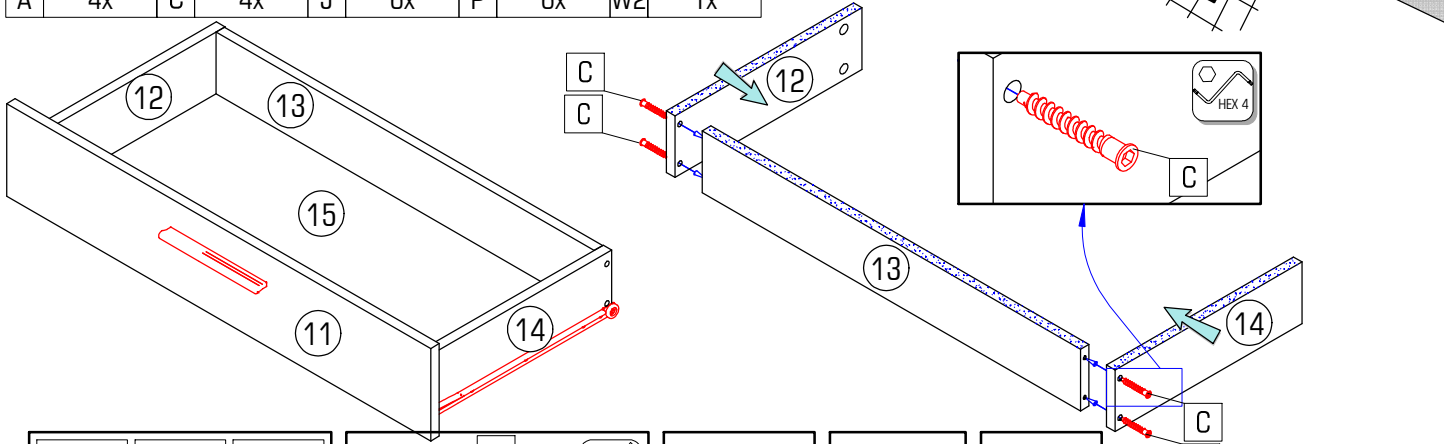
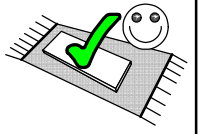
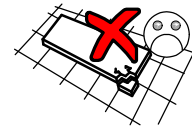
8/10 DOMIS NEW

A	C	J	P	W2
4x	4x	6x	6x	1x
	Ø7x50	Ø3,5x16	Ø3,5x15	350

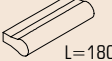

			
Ø3,5x15	Ø4x30	L=180	
P 16x	Q 8x	V 4x	Y1 8x

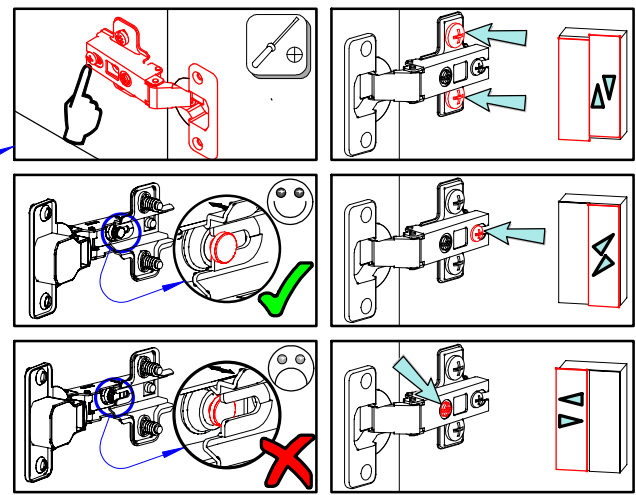
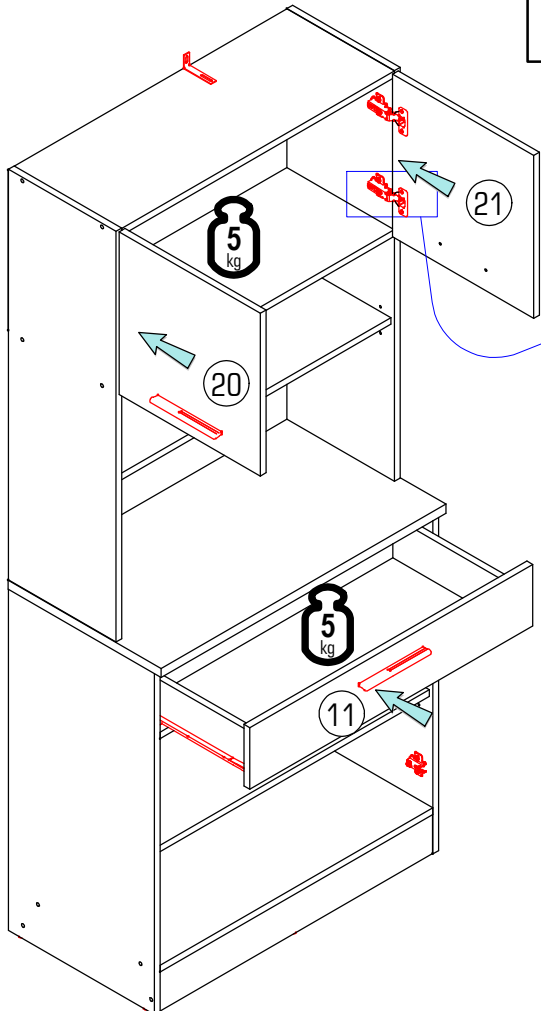
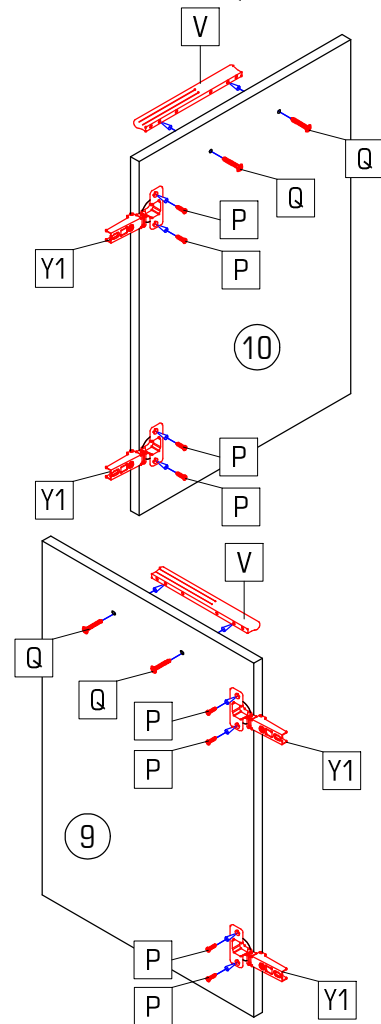
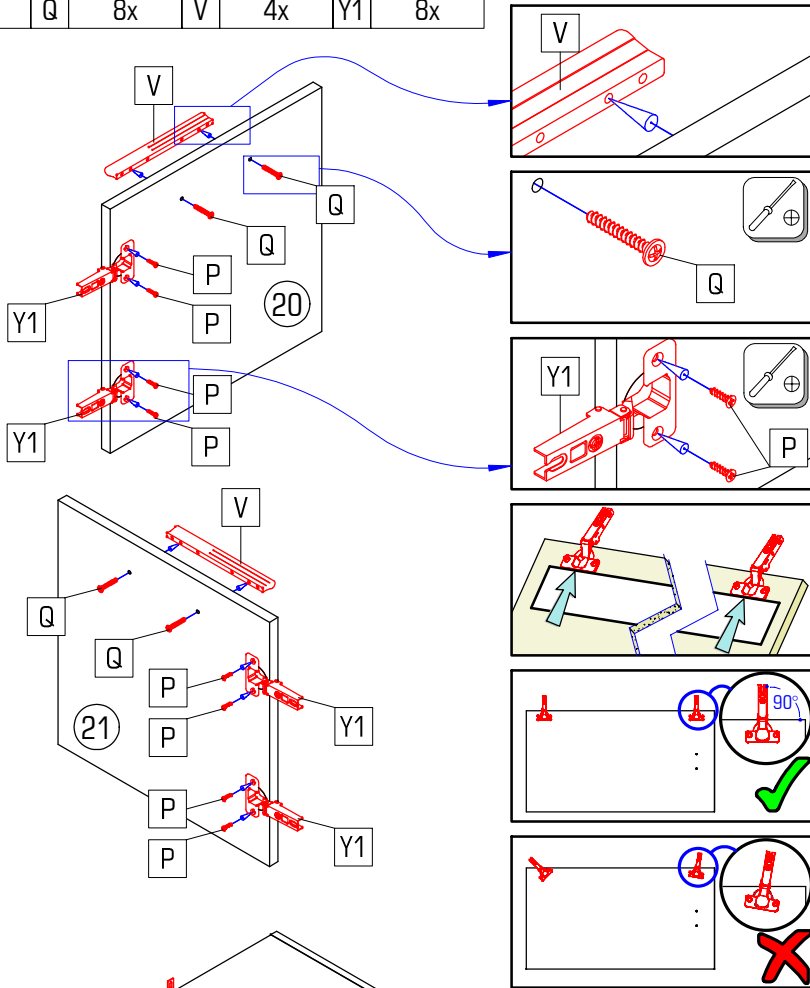
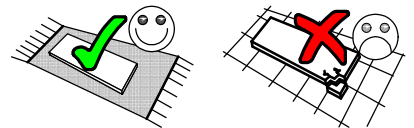

10/10 DOMIS NEW

